

**National Semiconductor
AnalogMicroControllers Group**

**COP8-PGMA-68PF1
Programming Adapter for COP8 Flash devices in 68PLCC
(COP8Sxx9, COP8Cxx9)
Rev 1, 7/1/01**

Only 17 pins are connected. Check the socket drawing for pin 1 location. Use Yamaichi lidded test socket IC51-0682-1513, or open-lid socket IC128-068

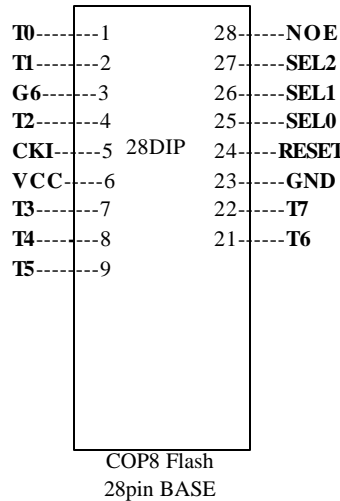
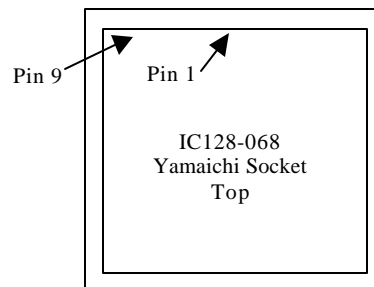
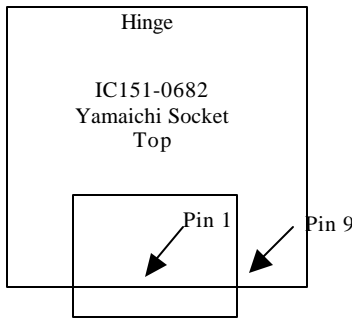
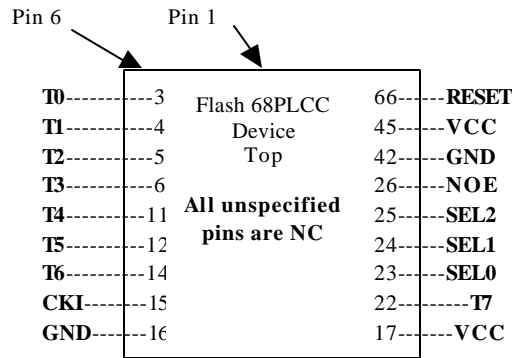

Label adapter:
COP8-PGMA-68PF1 Flash